

**UK**  
This tent should be erected by at least two persons.

**DE**  
Dieses Zelt sollte, wenn möglich, von zwei Personen aufgestellt werden.

**DK**  
Dette telt bør rejses af mindst to personer.

**NO**  
Dette teltet skal settes opp av minst to personer.

**FR**  
Cette tente doit être montée par au moins deux personnes.

**NL**  
Deze tent moet opgezet worden door minstens twee personen.

**CZ**  
Tento stan musí stavět nejméně dvě osoby.

PITCHING

PITCH TIME

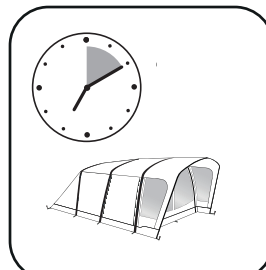

9 min.

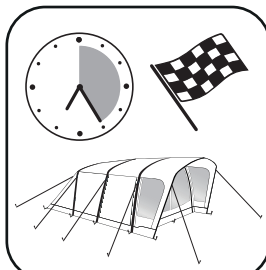

19 min.

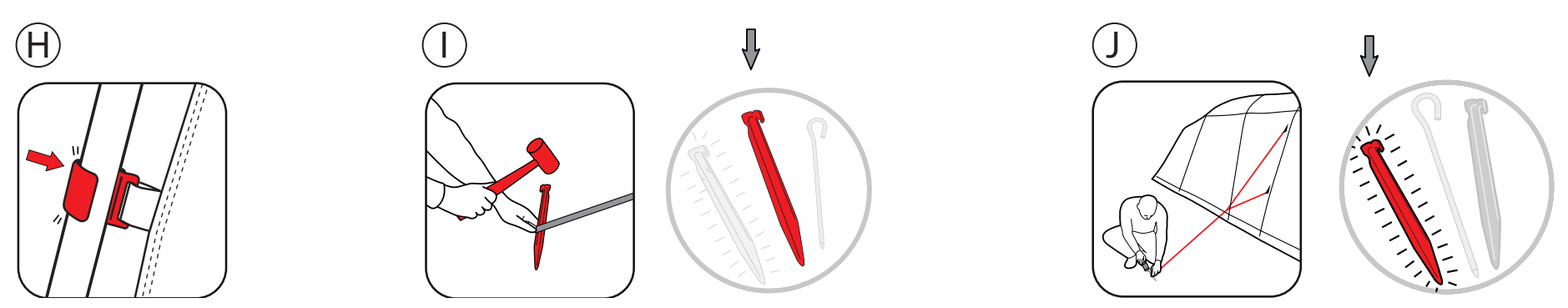
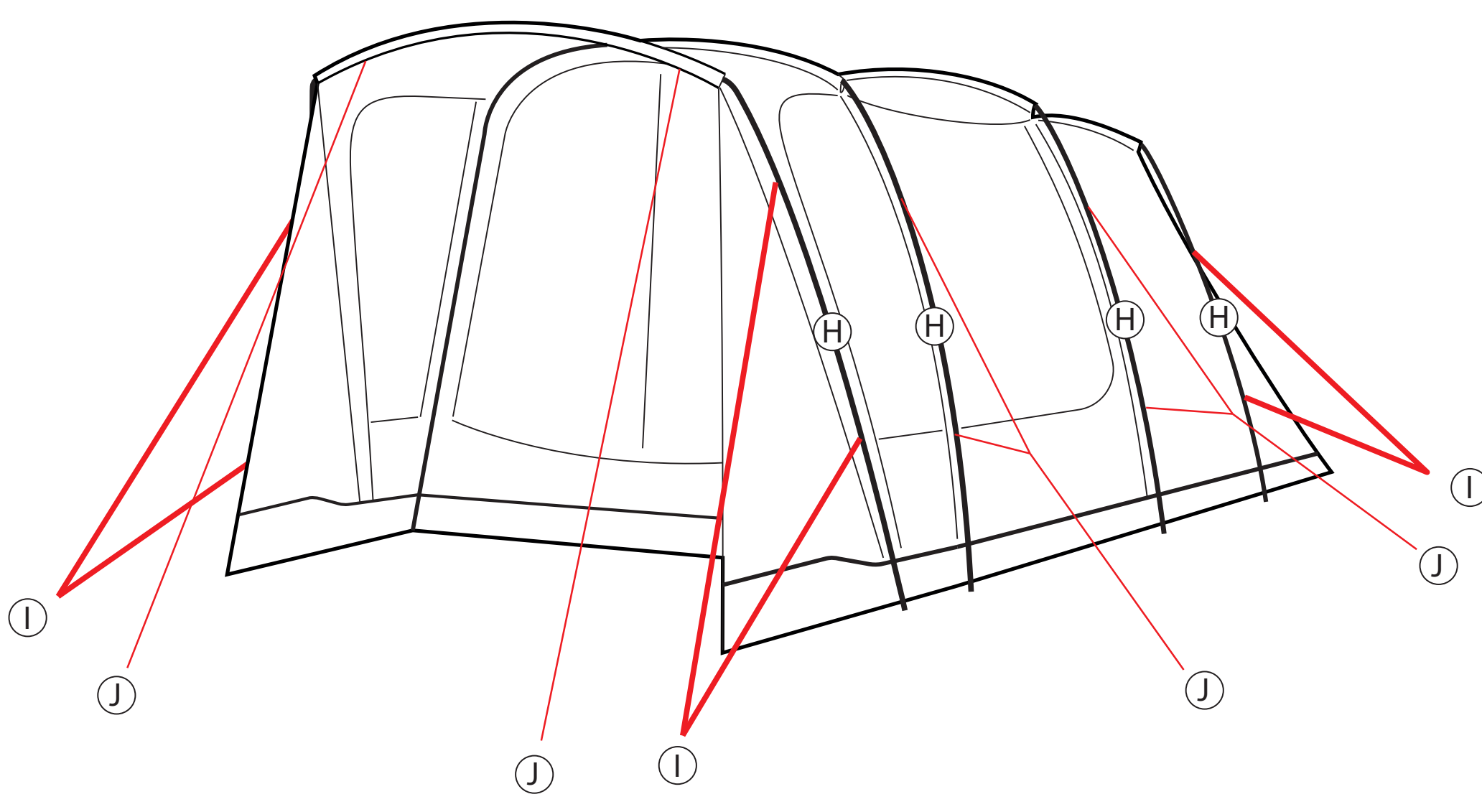
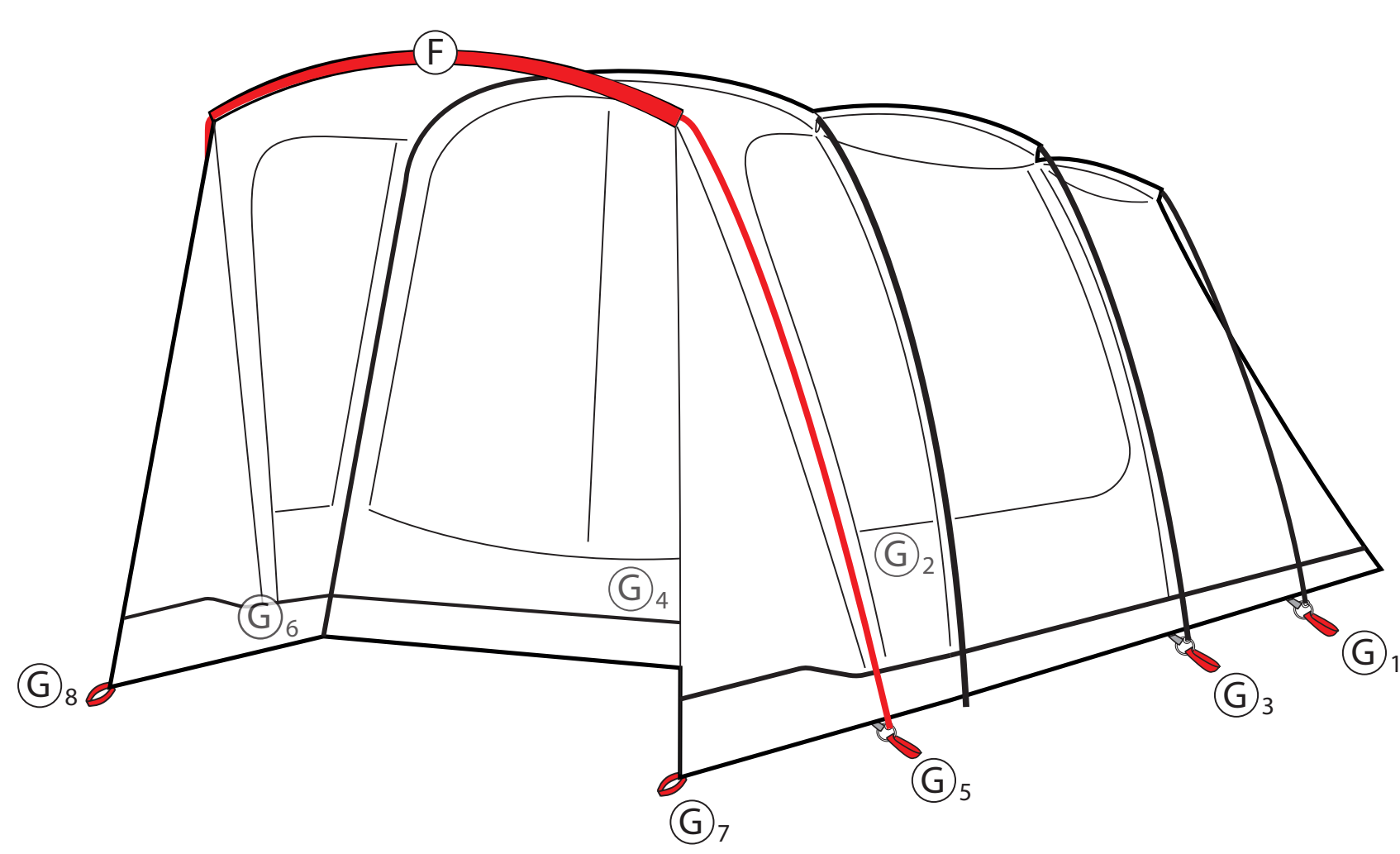
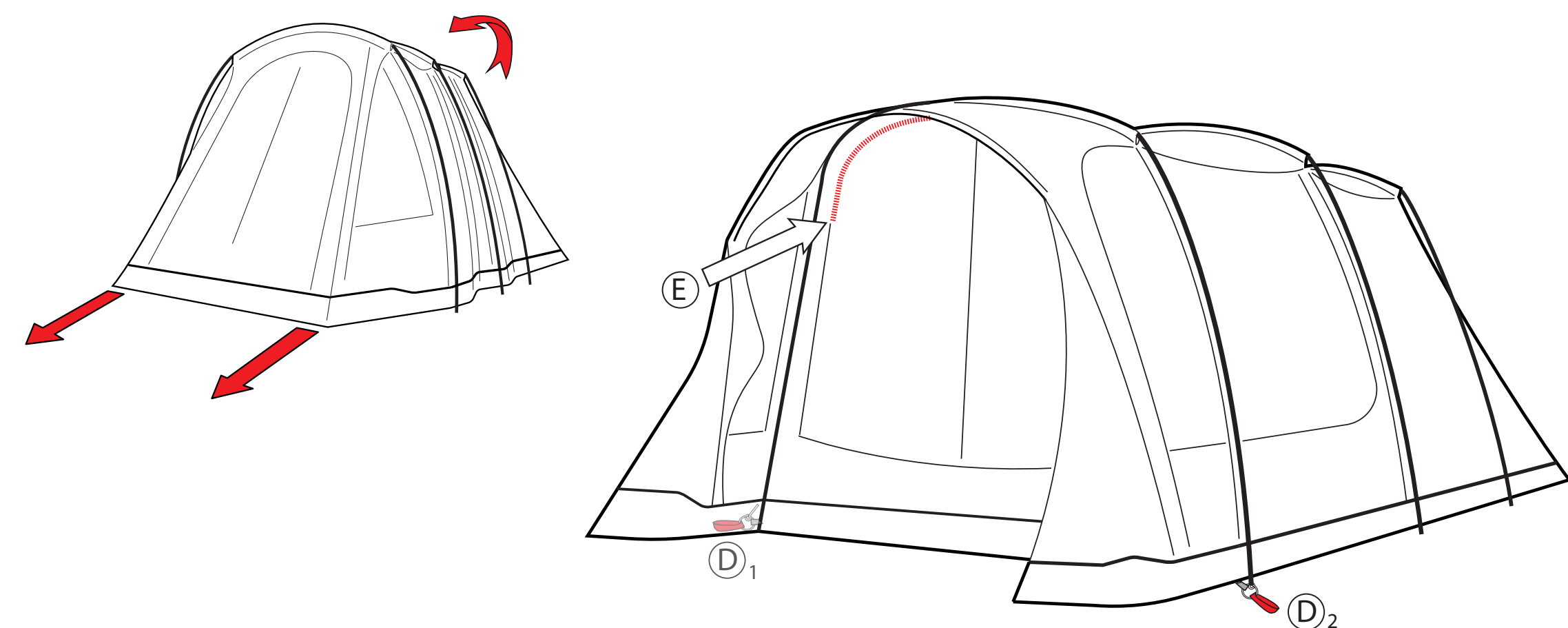
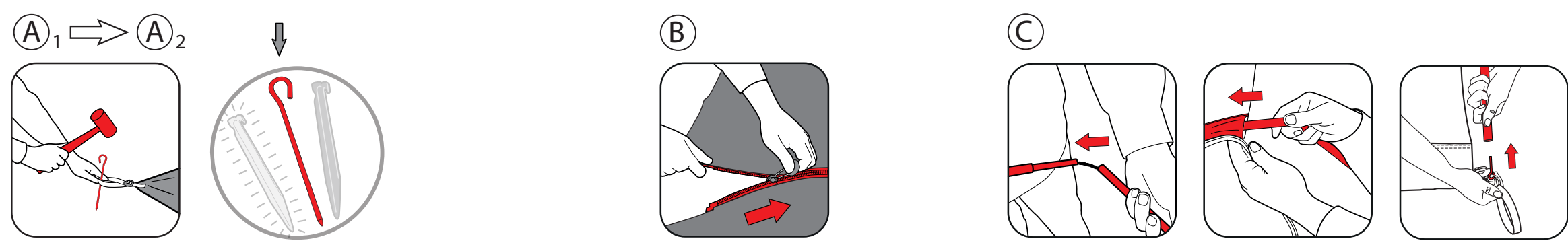
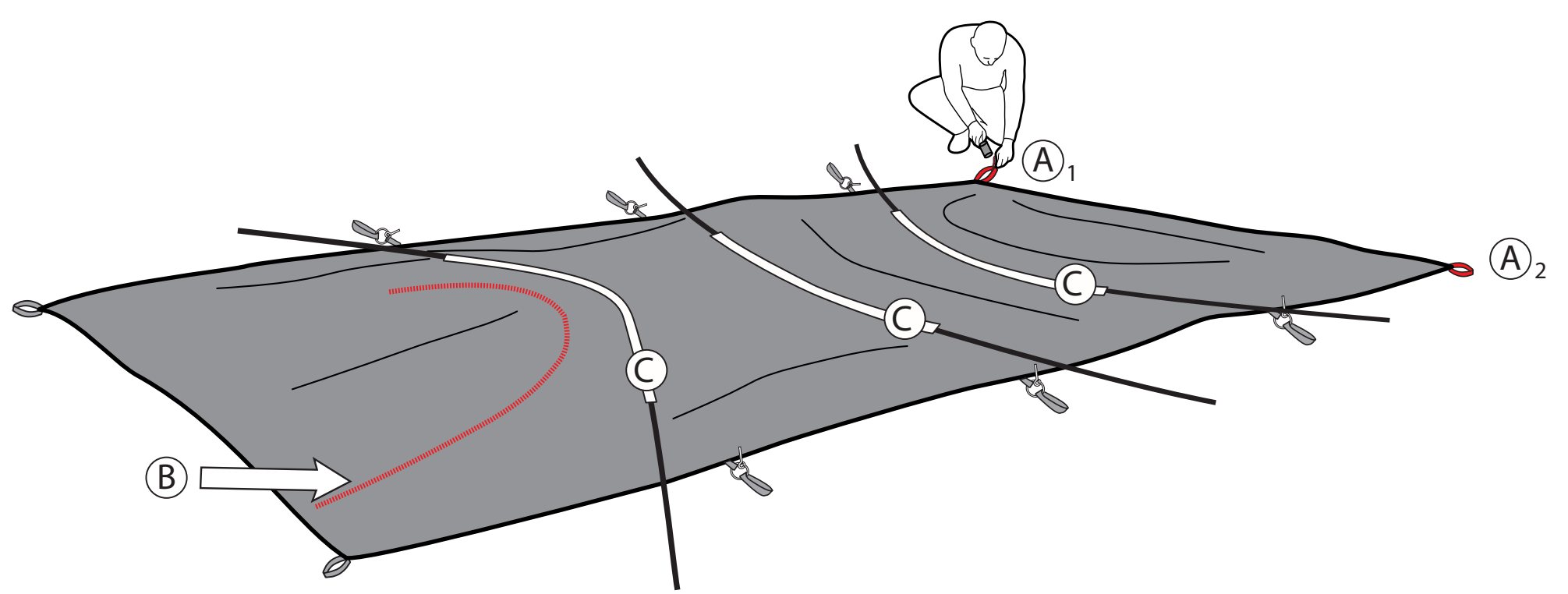

**FIND OUT!**  
See our videos  
HOW TO PITCH YOUR TENT?  
[www.youtube.com/user/Outwelltents](http://www.youtube.com/user/Outwelltents)  
HOW TO CLEAN AND MAINTAIN YOUR TENT?  
[www.outwell.com/maintenance](http://www.outwell.com/maintenance)

**FINDEN SIE ES HER-AUS!**  
Finden Sie es in unseren videos  
WIE BAUE ICH MEIN ZELT AUF?  
[www.youtube.com/user/Outwelltents](http://www.youtube.com/user/Outwelltents)  
WIE REINIGE UND PFLEGE ICH MEIN ZELT?  
[www.outwell.com/maintenance](http://www.outwell.com/maintenance)

**SÅDAN GØR DU!**  
Se vores videoer  
SÅDAN SÆTTER DU DIT TELT OP!  
[www.youtube.com/user/Outwelltents](http://www.youtube.com/user/Outwelltents)  
SÅDAN RENGØRER OG VEDLIGEHOLDER DU DIT TELT!  
[www.outwell.com/maintenance](http://www.outwell.com/maintenance)

**FINN UT MER!**  
Se videoene våre  
HVORDAN SETTER DU OPP TELTET DITT?  
[www.youtube.com/user/Outwelltents](http://www.youtube.com/user/Outwelltents)  
HVORDAN RENGJØR OG VEDLIKEHOLDER DU TELTET?  
[www.outwell.com/maintenance](http://www.outwell.com/maintenance)

**DÉCOUVREZ!**  
Regardez nos vidéos  
COMMENT MONTER VOTRE TENTE?  
[www.youtube.com/user/Outwelltents](http://www.youtube.com/user/Outwelltents)  
COMMENT NETTOYER ET ENTREtenir VOTRE TENTE!  
[www.outwell.com/maintenance](http://www.outwell.com/maintenance)

**ONTDEK HET HIER!**  
Bekijk onze video's  
HOE ZET U UW TENT OP?  
[www.youtube.com/user/Outwelltents](http://www.youtube.com/user/Outwelltents)  
HOE REINIGT EN ONDERHOUDT U UW TENT?  
[www.outwell.com/maintenance](http://www.outwell.com/maintenance)

**NEPŘEHLÉDNĚTE!**  
Podívejte se na naše videa  
JAK POSTAVIT STAN?  
[www.youtube.com/user/Outwelltents](http://www.youtube.com/user/Outwelltents)  
JAK ČISTIT A STARAT SE O STAN?  
[www.outwell.com/maintenance](http://www.outwell.com/maintenance)

